

Parts Listing - 54D

Ref	Part No	Description	Qty
1	54317	Chassis	1
2		Roller Complete	1
	20270	Solid Roller	
	20431	Ratchet Roller (includes 3-11+57)	
3	20431/01	Ratchet Roller Half	2
4	54288	Ratchet Roller Shaft	1
5	00499	Roller Bush	4
6	00775	Pawl	4
7	00943	Dome Cap (Before Jan 2004)	4
	10162	Nyloc Nut (After Jan 2004)	2
8	54287	Pawl Shaft (Before Jan 2004)	2
	10160	Bolt (After Jan 2004)	2
9	01014	Pawl Spring	4
10	01033	Spring Retainer	2
11	00142	Washer	As Req
12	43027	Bearing Housing - 2 Hole	2
13	00729	Bearing	2
14	00263	Sq Head Bolt	2
15	24245	Collar	2
16	00989	Dowel	2
17	00315/5	Eccentric Nut	1
18	00169	Bolt (Through Eccentric Nut)	1
19	00214	Bolt	3
20	10188	Nut	4
21	10187	Spring Washer	4
22	47277	Hand Knob	1
23	00367	O'ring	1
24	00085	Flat Washer	1
25	00754	Circlip	1
26	47314	Height Rod	1
27	10185	Nut	1
28	10161	Washer	1
29	00330	Nyloc Nut	1
30	00175	Bolt	2
31	00213	Spring Washer	2
32	00201	Nut	2
33	54345	Sole Plate	1
34		Shear Blade	1
	54264	Lipped	
	54300	Knife Edge	
	54301	Rectangular	
35	00211	Bolt	11
36	00278	Nut	11
37	00203	Bolt	4
38	10187	Spring Washer	4
39	10188	Nut	4
40	00729	Bearing	2
41	43027	Bearing Housing - 2 Hole	2

Parts Listing - 54D

Ref	Part No	Description	Qty
42	00755	Washer	2
43		Cutting Cylinder	1
	54256	6 Blade	
	54309	9 Blade	
	20489	Front Roller Complete (includes 44-50)	
44	20412	Roller Tube	1
45	18330	End Cap	2
46	00674	Bolt	2
47	00728	Bearing	2
48	00421	Nut	2
49	00679	Spring Washer	2
50	00678	Nut	2
51	00985	Dome Cap	2
52	54270	Front Roller Mounting	1
53	47271	Mounting Bracket	1
54	10200	Washer	1
55	10187	Spring Washer	1
56	10188	Nut	1
57	17432	Spacer	2

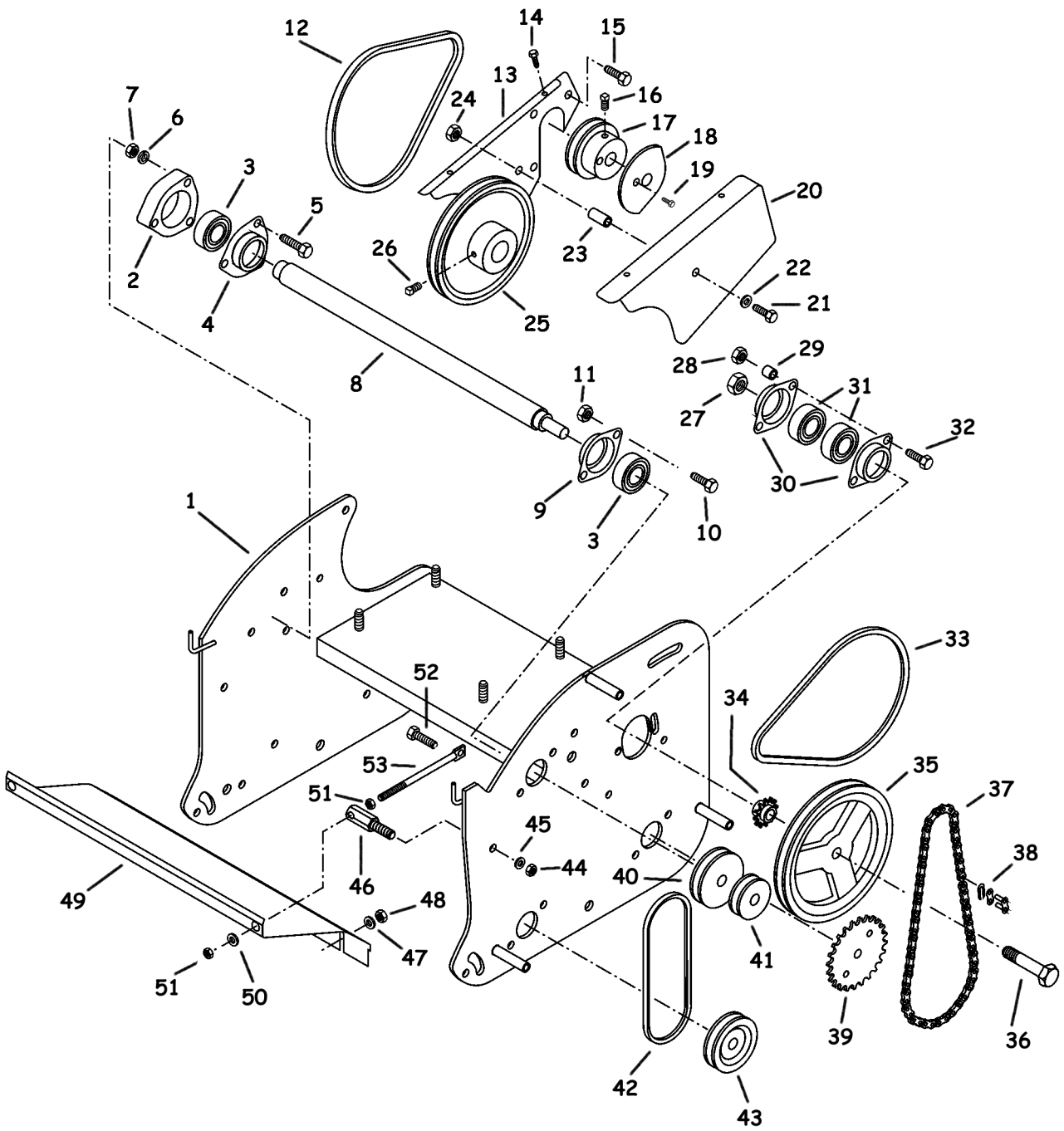

Parts Listing - 54D

Ref	Part No	Description	Qty
1	54317	Chassis	1
2	17325	Triangular Spacer	1
3	00729	Bearing	2
4	18359M	Bearing Housing - 3 Hole	1
5	00170	Bolt	3
6	10187	Spring Washer	3
7	10188	Nut	3
8	54308	Counter Shaft	1
9	43027	Bearing Housing - 2 Hole	1
10	00214	Bolt	2
11	10188	Nut	2
12	00104	Belt - Engine	1
13	54307	Backing Plate	1
14	54306	Screw	2
15	00730	Set Screw	3
16	00249	Sq Head Bolt	1
17	17340	Engine Pulley - Standard	1
	00502	Engine Pulley - Slower Ground Speed	
18	15325	Counterweight	1
19	15341	Screw	1
20	47306	Belt Guard	1
21	00845	Bolt	1
22	10200	Washer	1
23	47334	Spacer	1
24	00443	Nut	1
25	47305	Pulley - Counter Shaft	1
26	00249	Sq Head Bolt	1
27	76052	Nut	1
28	10188	Nut	2
29	54258	Spacer	2
30	43027	Bearing Housing - 2 Hole	2
31	00729	Bearing	2
32	00169	Bolt	2
33	36500	Belt - Roller Drive	1
34	47303	Sprocket - 10 Tooth	1
35	47302	Pulley - 8"	1
36	47309	Shaft	1
37	41-1	Chain - Per Foot	2
38	26/119040	Joiner	1
39	18318	Sprocket - 32 Tooth	1
40	47330	Pulley - Cylinder Drive	1
41	47331	Pulley - Roller Drive	1
42	47337	Belt - Cylinder Drive	1
43	47332	Pulley - Cylinder	1
44	10185	Nut	2
45	10186	Spring Washer	2

Parts Listing - 54D

Ref	Part No	Descripton	Qty
46	24372	Adjuster Boss	2
47	00465	Washer	2
48	10188	Nut	2
49	20408	Deflector	1
50	10161	Washer	2
51	10185	Nut	4
52	00214	Bolt	2
53	17243	Adjuster Rod	2

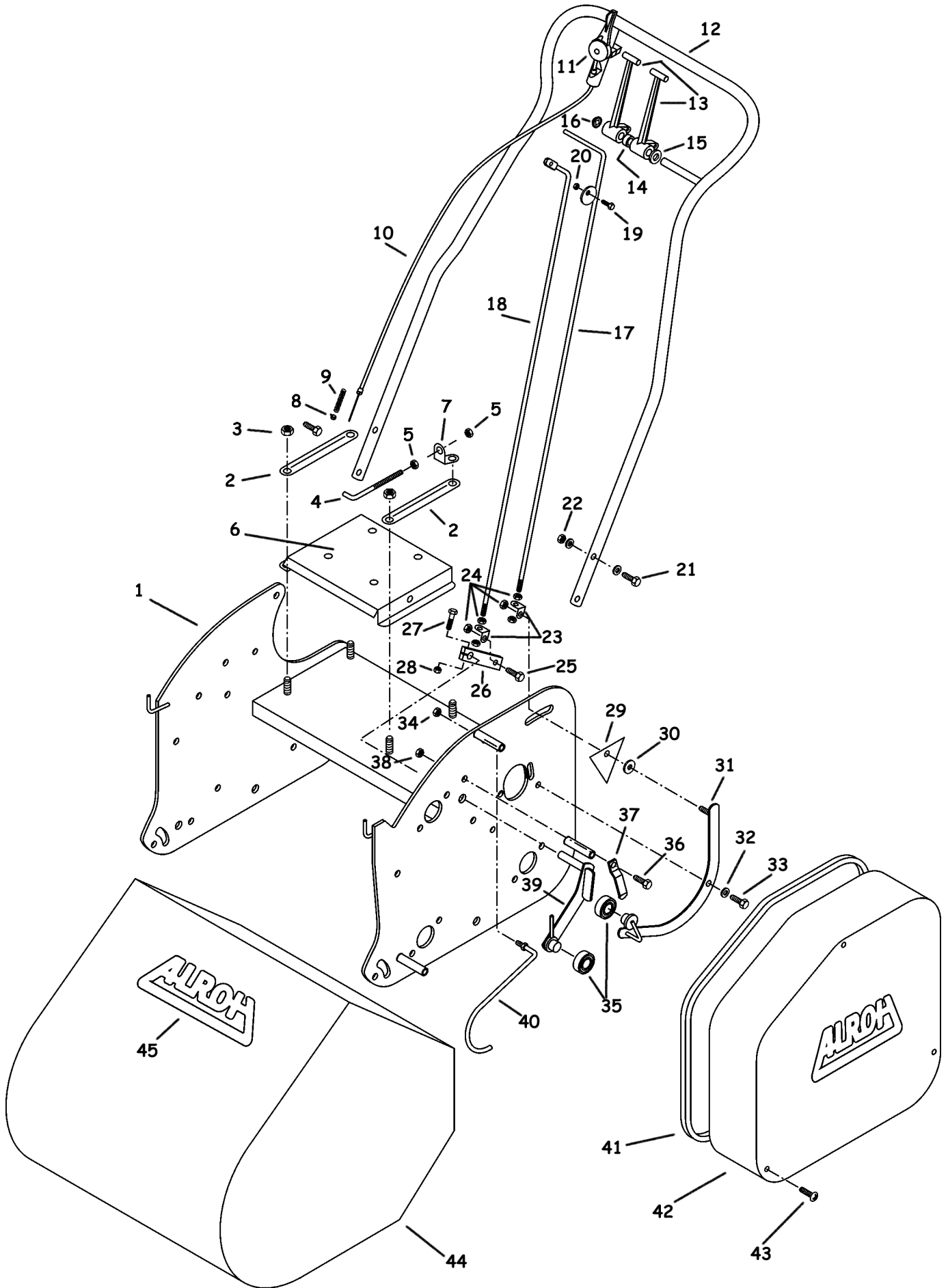

Parts Listing - 54D

Ref	Part No	Description	Qty
1	54317	Chassis	1
2	54274	Clamp Plate	2
3	10188	Nut	4
4	47326	Tensioner Bolt	1
5	10188	Nut	2
6	54280	Engine Plate	1
7	47329	Tensioner Bracket	1
8	00073	Retainer	1
9	00088	Spring	1
10	18284	Throttle Cable	1
11	00241	Controller	1
12	54338	Handle - Contour	1
	54311	Handle - 'A' Type	
	17280	Hand Grips - Suit 'A' Type (Pair)	
13	17294	Clutch Lever	2
14	47339	Spacer - Clutch Lever	1
15	00187	Washer	1
16	00985	Dome Cap	1
17	54339	Rod - Contour Handle	1
	47325	Rod - 'A' Type Handle	
	54314	Plastic Grip	1
18	17296	Rod - Cutter Engage	1
19	10182	Bolt	2
20	10176	Nut	2
21	00203	Bolt	4
22	10188	Nut	4
23	00077	L' Bracket	2
24	10188	Nut	6
25	00169	Bolt	1
26	00432	Clamp Arm	1
27	00740	Bolt	1
28	00739	Nut	1
29	47333	Triangular plate	1
30	10200	Washer	1
31	47319	Roller Belt Tensioner	1
32	10200	Washer	1
33	00203	Bolt	1
34	00221	Nut	2
35	00729	Bearing	2
36	00203	Bolt	1
37	47320	Retainer Plate	1
38	10188	Nut	1
39	47316	Clutch Arm - Cylinder Engage	1
40	47323	Belt Retainer	1
41	47336	Seal - Chain Case	1
42	47318	Chain Case	1

Parts Listing - 54D

Ref	Part No	Description	Qty
43	00308	Bolt	3
44	54324	Hopper	1
45	00504	Decal	2
Not Illustrated			
		Model Plate	1
	00554	Rivet	2